



# *Exeor MIG Torches*



## **Instruction manual**

0700 025 099 Rev. F / GB 202400522 V18-CX/DX



0 662067 229369



## EU DECLARATION OF CONFORMITY

**According to:**

The Low Voltage Directive 2014/35/EU

The RoHS Directive 2011/65/EU

**Type of equipment**

MIG/MAG welding torch

**Type designation**

Gas cooled variants: Exeor MIG 3.0G-S;  
Exeor MIG 3.0G<sup>2</sup>;  
Exeor MIG 4.0G<sup>2</sup>,

Liquid cooled variants: Exeor MIG 4.0W<sup>2</sup>,

**Brand name or trademark**

ESAB

**Manufacturer or his authorised representative established within the EEA**

ESAB AB

Lindholmsallén 9, Box 8004, SE-402 77 Göteborg, Sweden

Phone: +46 31 50 90 00, [www.esab.com](http://www.esab.com)

**The following EN standards and regulations in force within the EEA has been used in the design:**

EN IEC 60974-7:2019

Arc welding equipment - Part 7: Torches

**Additional Information:**

Restrictive use, Class A equipment, intended for use in locations other than residential.

**By signing this document, the undersigned declares as manufacturer, or the manufacturer's authorised representative established within the EEA, that the equipment in question complies with the safety and environmental requirements stated above.**

**Place/Date**

Gothenburg  
2023-11-02

**Signature**

Peter Burchfield  
General Manager, Equipment Solutions





## EU DECLARATION OF CONFORMITY

**According to:**

The Low Voltage Directive 2014/35/EU;      The EMC Directive 2014/30/EU;  
The RoHS Directive 2011/65/EU

**Type of equipment**

MIG/MAG welding torch

**Type designation**

Gas cooled variants:      Exeor MIG 3.0G-S CX;      Exeor MIG 4.0G<sup>2</sup> CX;  
   Exeor MIG 4.0G<sup>2</sup> DX;  
   Exeor MIG 4.0G<sup>2</sup> BX

Liquid cooled variants:      Exeor MIG 4.0W<sup>2</sup> CX;      Exeor MIG 4.0W<sup>2</sup> DX  
   Exeor MIG 4.0W<sup>2</sup> BX

**Brand name or trademark**

ESAB

**Manufacturer or his authorised representative established within the EEA**

ESAB AB  
Lindholmsallén 9, Box 8004, SE-402 77 Göteborg, Sweden  
Phone: +46 31 50 90 00, www.esab.com

**The following EN standards and regulations in force within the EEA has been used in the design:**

EN IEC 60974-7:2019	Arc welding equipment - Part 7: Torches
EN 60974-10:2021	Arc Welding Equipment - Part 10: Electromagnetic compatibility (EMC) requirements

**Additional Information:**

Restrictive use, Class A equipment, intended for use in locations other than residential.

**By signing this document, the undersigned declares as manufacturer, or the manufacturer's authorised representative established within the EEA, that the equipment in question complies with the safety and environmental requirements stated above.**

**Place/Date**

Gothenburg  
2023-11-02

**Signature**

Peter Burchfield  
General Manager, Equipment Solutions





## UK DECLARATION OF CONFORMITY

### According to:

- Electric Equipment (Safety) Reg. 2016
- Electromagnetic Compatibility Reg. 2016
- The Restriction of Use of Certain
- Hazardous Substances in Electrical and Electronic Equipment Regulations 2012

### Type of equipment

MIG/MAG welding torch

### Type designation

Gas cooled variants: Exeor MIG 3.0G<sup>2</sup> RP; Exeor MIG 4.0G<sup>2</sup> BX; Exeor MIG 4.0G<sup>2</sup>  
Liquid cooled variants: Exeor MIG 4.0GW<sup>2</sup> BX; Exeor MIG 4.0W<sup>2</sup>

### Brand name or trademark

ESAB

### Manufacturer or his authorised representative established within United Kingdom

ESAB Group (UK) Ltd,  
322 High Holborn, London, WC1V 7PB, United Kingdom  
www.esab.co.uk

**The following British Standards and Instruments in force within the United Kingdom has been used in the design:**

- EN IEC 60974-7:2019	Arc welding equipment - Part 7: Torches
-----------------------	---

### Additional Information:

Restrictive use, Class A equipment, intended for use in locations other than residential.

**By signing this document, the undersigned declares as manufacturer, or the manufacturer's authorised representative established within the UK, that the equipment in question complies with the safety and environmental requirements stated above.**

### Signatures

Gary Kisby  
Sales & Marketing Director,  
ESAB Group UK & Ireland  
London, 2022-03-24



## UK DECLARATION OF CONFORMITY

### According to:

- Electric Equipment (Safety) Reg. 2016
- Electromagnetic Compatibility Reg. 2016
- The Restriction of Use of Certain Hazardous Substances in Electrical and Electronic Equipment Regulations 2012

### Type of equipment

MIG/MAG welding torch

### Type designation

Gas cooled variants: Exeor MIG 4.0G<sup>2</sup> CX; Exeor MIG 4.0G<sup>2</sup> DX;  
Exeor MIG 3.0G<sup>2</sup> RP CX; Exeor MIG 3.0G<sup>2</sup> RP DX;  
Liquid cooled variants: Exeor MIG 4.0W<sup>2</sup> CX; Exeor MIG 4.0W<sup>2</sup> DX

### Brand name or trademark

ESAB

### Manufacturer or his authorised representative established within United Kingdom

ESAB Group (UK) Ltd,  
322 High Holborn, London, WC1V 7PB, United Kingdom  
[www.esab.co.uk](http://www.esab.co.uk)

### The following British Standards and Instruments in force within the United Kingdom has been used in the design:

- EN IEC 60974-7:2019	Arc welding equipment - Part 7: Torches
- EN 60974-10:2014	Arc welding equipment - Part 10: Electromagnetic compatibility (EMC)

### Additional Information:

Restrictive use, Class A equipment, intended for use in locations other than residential.

**By signing this document, the undersigned declares as manufacturer, or the manufacturer's authorised representative established within the UK, that the equipment in question complies with the safety and environmental requirements stated above.**

### Signatures

Gary Kisby  
Sales & Marketing Director,  
ESAB Group UK & Ireland  
London, 2022-03-24

UK  
CA

## TABLE OF CONTENTS

1.	SAFETY.....	8
1.1	Meaning of symbols .....	8
1.2	Safety precautions .....	8
2.	INTRODUCTION .....	11
2.1	Shipment and packaging.....	11
3.	TECHNICAL DATA .....	11
4.	OPERATION.....	14
4.1	Fitting the liner .....	14
4.2	Equipping the torch .....	14
4.3	Fitting the central adaptor to the equipment .....	14
4.4	Connecting the cooling circuit .....	15
4.5	Setting the level of shielding gas.....	15
4.6	Checklist .....	15
4.7	Changing wire.....	15
4.8	Starting and stopping the welding process .....	15
5.	REMOTE CONTROL .....	16
5.1	CX - Remote module.....	16
5.2	DX - Remote module.....	18
5.3	Software upgrade procedure.....	21
6.	MAINTENANCE.....	22
6.1	Overview.....	22
6.2	Cable assembly .....	22
6.3	Cleaning the wire feed .....	22
6.4	Steel liner / Plastic liner.....	22
6.5	Cleaning the swan neck .....	24
6.6	Checking the cooling system.....	24
7.	TROUBLESHOOTING .....	25
8.	DISASSEMBLY AND DISPOSAL .....	26
9.	IN THE EVENT OF EMERGENCY .....	26
10.	ORDERING PARTS.....	26
11.	ORDERING NUMBERS.....	27
12.	REPLACING THE PCBA BOARD .....	28
13.	SPARE PARTS.....	28
13.1	Exeor MIG 4.0W <sup>2</sup> CX, DX .....	28
13.2	Exeor MIG 4.0W <sup>2</sup> .....	30
13.3	Exeor MIG 4.0G <sup>2</sup> CX, DX .....	32

13.4	Exeor MIG 4.0G <sup>2</sup> .....	34
14.	WEAR PARTS Exeor MIG 4.0W <sup>2</sup> .....	35
14.1	Contact Tips M8.....	35
14.2	Contact Tips M6.....	36
14.3	Steel liner.....	36
14.4	PTFE liner.....	37
14.5	PTFE liner with bronze front end.....	37
14.6	PA liner with bronze front end.....	37
15.	WEAR PARTS Exeor MIG 4.0G <sup>2</sup> .....	38
15.1	Contact Tips; Standard 16S-Series.....	38
15.2	Steel liner.....	39
15.3	PTFE liner.....	39
15.4	PTFE liner with bronze front end.....	39
15.5	PA liner with bronze front end.....	40

Rights reserved to alter specifications without notice.

# 1. SAFETY

## 1.1 Meaning of symbols

As used throughout this manual: Means Attention! Be Alert!



### **DANGER!**

Means immediate hazards which, if not avoided, will result in immediate, serious personal injury or loss of life.



### **WARNING!**

Means potential hazards which could result in personal injury or loss of life.



### **CAUTION!**

Means hazards which could result in minor personal injury.



### **WARNING!**

Before use, read and understand the instruction manual and follow all labels, employer's safety practices and Safety Data Sheets (SDSs).



## 1.2 Safety precautions

Users of ESAB equipment have the ultimate responsibility for ensuring that anyone who works on or near the equipment observes all the relevant safety precautions. Safety precautions must meet the requirements that apply to this type of equipment. The following recommendations should be observed in addition to the standard regulations that apply to the workplace.

All work must be carried out by trained personnel well-acquainted with the operation of the equipment. Incorrect operation of the equipment may lead to hazardous situations which can result in injury to the operator and damage to the equipment.

1. Anyone who uses the equipment must be familiar with:
  - its operation
  - location of emergency stops
  - its function
  - relevant safety precautions
  - welding and cutting or other applicable operation of the equipment
2. The operator must ensure that:
  - no unauthorized person is stationed within the working area of the equipment when it is started up
  - no-one is unprotected when the arc is struck, or work is started with the equipment
3. The workplace must:
  - be suitable for the purpose
  - be free from drafts
4. Personal safety equipment:
  - Always wear recommended personal safety equipment, such as safety glasses, flame-proof clothing, safety gloves
  - Do not wear loose-fitting items, such as scarves, bracelets, rings, etc., which could become trapped or cause burns



5. General precautions:

- Make sure the return cable is connected securely
- Work on high voltage equipment **may only be carried out by a qualified electrician**
- Appropriate fire extinguishing equipment must be clearly marked and close at hand
- Lubrication and maintenance must **not** be carried out on the equipment during operation



**WARNING!**

Arc welding and cutting can be injurious to yourself and others. Take precautions when welding and cutting.



**ELECTRIC SHOCK - Can kill**

- Install and ground the unit in accordance with instruction manual.
- Do not touch live electrical parts or electrodes with bare skin, wet gloves, or wet clothing.
- Insulate yourself from work and ground.
- Ensure your working position is safe



**ELECTRIC AND MAGNETIC FIELDS - Can be dangerous to health**

- Welders having pacemakers should consult their physician before welding. EMF may interfere with some pacemakers.
- Exposure to EMF may have other health effects which are unknown.
- Welders should use the following procedures to minimize exposure to EMF:
  - Route the electrode and work cables together on the same side of your body. Secure them with tape when possible. Do not place your body between the torch and work cables. Never coil the torch or work cable around your body. Keep welding power source and cables as far away from your body as possible.
  - Connect the work cable to the workpiece as close as possible to the area being welded.



**FUMES AND GASES - Can be dangerous to health**

- Keep your head out of the fumes.
- Use ventilation, extraction at the arc, or both, to take fumes and gases away from your breathing zone and the general area.



**ARC RAYS - Can injure eyes and burn skin**

- Protect your eyes and body. Use the correct welding screen and filter lens and wear protective clothing.
- Protect bystanders with suitable screens or curtains.



**NOISE - Excessive noise can damage hearing**

Protect your ears. Use earmuffs or other hearing protection.



### MOVING PARTS - Can cause injuries



- Keep all doors, panels and covers closed and securely in place. Have only qualified people remove covers for maintenance and troubleshooting as necessary. Reinstall panels or covers and close doors when service is finished and before starting engine.
- Stop engine before installing or connecting unit.
- Keep hands, hair, loose clothing and tools away from moving parts.



### FIRE HAZARD

- Sparks (spatter) can cause fire. Make sure that there are no inflammable materials nearby.
- Do not use on closed containers.

## MALFUNCTION - Call for expert assistance in the event of malfunction. PROTECT YOURSELF AND OTHERS!



### CAUTION!

This product is solely intended for arc welding.



### WARNING!

Do not use the power source for thawing frozen pipes.



### CAUTION!

Class A equipment is not intended for use in residential locations where the electrical power is provided by the public low-voltage supply system. There may be potential difficulties in ensuring electromagnetic compatibility of class A equipment in those locations, due to conducted as well as radiated disturbances.

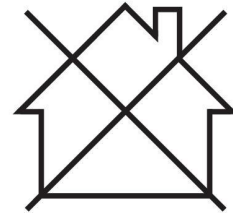

### NOTE!

#### Dispose of electronic equipment at the recycling facility!

In observance of European Directive 2012/19/EC on Waste Electrical and Electronic Equipment and its implementation in accordance with national law, electrical and/or electronic equipment that has reached the end of its life must be disposed of at a recycling facility.

As the person responsible for the equipment, it is your responsibility to obtain information on approved collection stations.

For further information contact the nearest ESAB dealer.



**ESAB has an assortment of welding accessories and personal protection equipment for purchase. For ordering information contact your local ESAB dealer or visit us on our website.**

## 2. INTRODUCTION

The MIG / MAG welding torches of this series are exclusively intended for shielded- arc welding using inert gas (MIG) or active gas (MAG) for industrial and commercial use by suitably trained employees. The torches are only available in manual versions.

### 2.1 Shipment and packaging

The components are carefully checked and packaged; however, damage may occur during shipping.

#### 2.1.1 Checking procedure on receipt of goods

Check that the shipment is correct by referring to the shipping note.

#### 2.1.2 In case of damage

Check the package and components for damage (visual inspection).

#### 2.1.3 In case of complaints

If the package and/or components have been damaged during shipment:

- Contact with the last carrier immediately.
- Keep the packaging (for possible inspection by the carrier or supplier, or for returning the goods).

#### 2.1.4 Storage in an enclosed space

Ambient temperature for shipment and storage: -20 °C to +55 °C

Relative air humidity: up to 90% at a temperature of 20 °C

## 3. TECHNICAL DATA

Welding torch	Exeor MIG 4.0W <sup>2</sup>	Exeor MIG 4.0W <sup>2</sup> CX	Exeor MIG 4.0W <sup>2</sup> DX
Type of cooling*	Liquid-cooled	Liquid-cooled	Liquid-cooled
<b>Torch rating and duty cycle, using**</b>			
Carbon dioxide CO <sub>2</sub>	450 A / 100% DC	450 A / 100% DC	450 A / 100% DC
Mixed gas, Ar/CO <sub>2</sub> M21	450 A / 100% DC	450 A / 100% DC	450 A / 100% DC
Recommended gas flow	10-20 l/min	10-20 l/min	10-20 l/min
Wire diameter	0.8-1.6 mm	0.8-1.6 mm	0.8-1.6 mm
Operating temperature***	-10 °C to 40 °C	-10 °C to 40 °C	-10 °C to 40 °C

\* An appropriate cooling liquid must be used.

\*\* The capacity may be reduced up to 30% when pulse welding.

\*\*\* When using liquid cooled torches in freezing conditions, use an adequate cooling liquid.

Welding torch	Exeor MIG 4.0G <sup>2</sup>	Exeor MIG 4.0G <sup>2</sup> CX	Exeor MIG 4.0G <sup>2</sup> DX
Type of cooling	Gas-cooled	Gas-cooled	Gas-cooled
<b>Torch rating and duty cycle, using*</b>			
Carbon dioxide CO <sub>2</sub>	420 A / 60% DC	420 A / 60% DC	360 A / 60% DC
Mixed gas, Ar/CO <sub>2</sub> M21	420 A / 60% DC	420 A / 60% DC	360 A / 60% DC
Recommended gas flow	10-20 l/min	10-20 l/min	10-20 l/min
Wire diameter	0.8-1.6 mm	0.8-1.6 mm	0.8-1.6 mm
Operating temperature	-10 °C to 40 °C	-10 °C to 40 °C	-10 °C to 40 °C

\* The capacity may be reduced up to 30% when pulse welding.

### Duty cycle

The duty cycle refers to the time as a percentage of a ten-minute period that you can weld at a certain load without overloading. The duty cycle is valid for 40 °C / 104 °F, or below.

<b>General torch data with reference IEC 60974-7:2019</b>	
Type of guidance:	Manual
Wire type:	Standard round wire
Voltage rating:	The control circuit and trigger switch are rated for a voltage of 24 V, max. 1 A
Specifications of the torch cooling circuit (For liquid cooled torches only):	<ul style="list-style-type: none"> <li>• minimum flow 1.2 l/min</li> <li>• min. liquid pressure: 2.5 bar</li> <li>• max. liquid pressure: 3.5 bar</li> <li>• input temperature: max. 40 °C</li> <li>• return temperature: max. 60 °C</li> <li>• cooling capacity: minimum 1000 W, up to 2000 W depending on the application</li> </ul>

### Liquid cooled torches

Return temperatures of more than 60 °C can shorten the lifetime of the torch or cause damage or destruction of the torch. The cooler must always be filled with sufficient cooling liquid, refer to the instruction manual for the cooling unit. In case of a high thermal load on the torch, use a cooler with sufficient capacity. Use only special cooling fluid containing corrosion inhibitors for welding torches. For suitable products, contact your nearest ESAB dealer.

The ratings are valid for cable lengths from 3.0 to 5.0 m.

The rated loads refer to a standardized case of use. Under special conditions, e.g. in case of high heat reflection on the torch, the torch could overheat even when operated below the rated load. In this case choose a more powerful model or lower the duty cycle.

## Conditions of intended use

1. The welding torch should only be used within the above-mentioned technical specifications and for its intended purpose.
2. The type of torch must be chosen according to the welding application. The required duty-cycle and load, the type of cooling, guiding method and the wire diameter must be considered. If increased requirements exist, for example caused by pre-heated work pieces, high heat reflection in corners, etc. these must be considered by choosing a welding torch with adequate reserve in rated load.
3. The product must be protected from humidity and moisture during transport, storage and operation.

## 4. OPERATION

General safety regulations for handling the equipment can be found in the "SAFETY" chapter of this manual. Read it through before you start using the equipment!



### CAUTION!

This product is intended for industrial use. In a domestic environment this product may cause radio interference. It is the user's responsibility to take adequate precautions.



### DANGER!

In the event of an emergency, the power supply must be switched off immediately. For further action in such circumstances, refer to the instruction manual for the power source for more information.

The welding torch can be used in any welding position.

Contact with hot items might cause damage to the torch and the cable assembly.

Do not drag the power source using the torch.

Do not pull the cable assembly over sharp edges. Do not bend the cable assembly sharply.

### 4.1 Fitting the liner

Fit the correct wire guide liner for the application, as needed to suit the wire type and diameter. See chapter "MAINTENANCE" section "Steel liner / Plastic liner".



### NOTE!

**For information on how to install new liners and about correct assembly procedure, see the chapter entitled "Maintenance"**

Steel liner = for steel wires

Plastic liner = for aluminum, copper, nickel and stainless-steel wires

### 4.2 Equipping the torch

The torch must be equipped according to the wire diameter and wire material. Choose the right liner, contact tip, tip adaptor, gas nozzle and gas diffuser (as applicable). A detailed overview of the suitable parts is found in the spare parts list for the torch.

Tighten the tip adaptor and the contact tip with an adequate tool.

Make sure that all required parts shown in the spare parts list, e.g. insulators, are installed. Welding without these items might cause immediate destruction of the torch.

### 4.3 Fitting the central adaptor to the equipment

1. Check that the wire guide liner is fitted correctly.
2. Insert the central plug into the socket on the wire feed unit and secure it by tightening the adaptor nut firmly by hand.

## 4.4 Connecting the cooling circuit

Connect the liquid hoses to the cooling unit: blue for liquid flow forward from the cooler to the torch; red for heated liquid flow backwards from the torch to the cooler. Before using a liquid-cooled torch, the air must be removed from the cooling circulation by running the cooler for a few minutes.



### CAUTION!

Wrongly connected liquid hoses can cause overheating and damage of the torch neck and liquid-power cable. Regularly check the coolant level and throughput on the cooling unit. Insufficient cooling might cause overheating and damage of the torch neck and liquid-power cable.



### NOTE!

To achieve an optimal gas and liquid flow, place the cable assemblies and the gas and liquid hoses as straight as possible. Kinked hoses will cause overheating and can damage the torch. Protect cables and supply hoses from damage.

## 4.5 Setting the level of shielding gas

Set the quantity of gas required on the gas regulator. The type and quantity of gas to be used depend on the welding task to be performed.

## 4.6 Checklist

Check the cable assembly before connecting it to the wire feed unit to confirm the wire liner is suitable for the wire diameter and type.

Check the front-end consumable parts on the swan neck, whether the correct contact tip etc. is being used for the wire diameter and type.

## 4.7 Changing wire

When changing the wire, ensure that the end of the wire is deburred.

Insert the wire into the wire feeding unit in accordance with the operating instructions.

When inserting the wire, press the wire jog button on the wire feed unit.

## 4.8 Starting and stopping the welding process

The wire feeder and the welding process will be started by pulling the torch trigger. Depending on the configuration of the welding machine, the welding process will be stopped by either letting go of the trigger or by pulling the trigger a second time. Refer to the instruction manual for the power source for more information.



### DANGER!

The torch head might reach very high temperatures during operation, there is a risk of severe burns. Let it cool down under observation, there is risk of fire. Do not place the hot torch on or near heat-sensitive objects. For liquid-cooled torches, the cooling system should remain switched on for some minutes after the welding process has been stopped.

When leaving the workplace, the system must be secured against unintended operation, preferably by switching off the power source.

## 5. REMOTE CONTROL

### 5.1 CX - Remote module

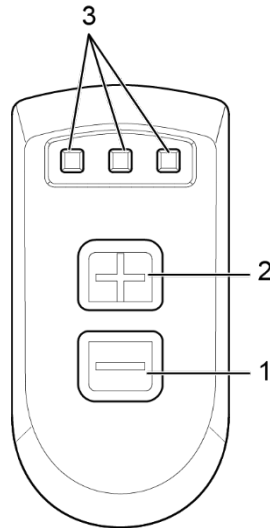

- 1 The Button to decrease the value
- 2 The Button to increase the value
- 3 LEDs

#### 5.1.1 Starting procedure

When the torch is connected to the system, all LEDs will be lit in green.

#### 5.1.2 Torch configuration

The function needs to be activated on the torch can be selected from the Inner control panel of RobustFeed Edge under “Menu → System settings → Torch remote configuration → CX Torch module”. Turn ON “Activate Remote functionality”, to enable the required function to be activated on torch. Only one function can be active at a time.

The torch remotes can be configured even if there are no torch remotes connected to the system. Changes in the configuration can have direct impact to the torch remote if it is connected and active.

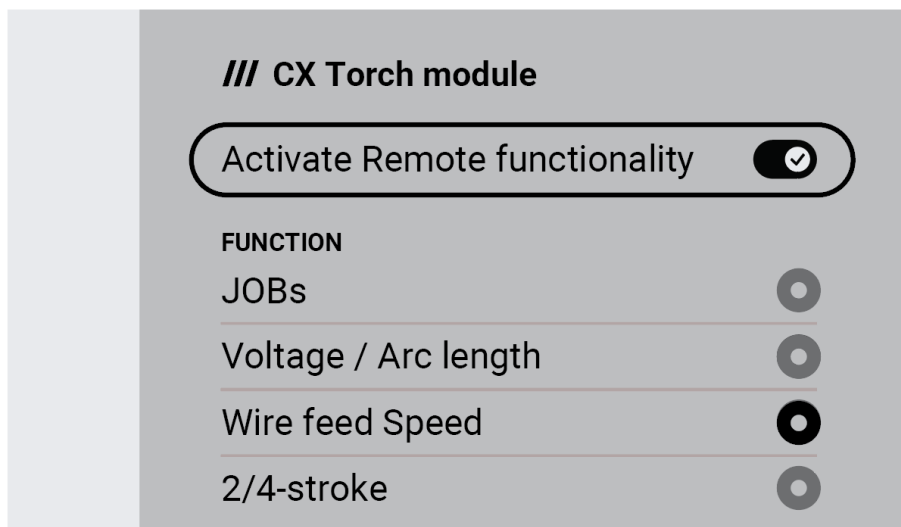



### 5.1.3 Functions

By pressing the buttons (1 & 2), the values of the selected function can be decreased and increased respectively. In the first press, the PCBA LED will lit for 10 seconds and then the associated function will be enabled on the next press.

The decremental and incremental of the selected functional values are varied for a single button press as shown.

Function	Value
JOBs	1 Job
Voltage	0.1 V
Arc length	0.1
Wire feed speed	0.1 m/min 1 inch/min
2/4 stroke	Button 1 – 2 stroke Button 2 – 4 stroke

For Jobs function, the first 3 jobs represent the 3 LEDs. If a first job is activated, then first LED will be lit in green.



#### **NOTE!**

For Voltage, Arc length and Wire feed speed, the long press of buttons (1 & 2) will set to lower / upper limit values respectively.

### 5.1.4 Warning / Error

#### **Warning**

The warning codes are used to indicate the warning message to show the critical limits. Warning does not stop ongoing welding but prevent new welding until the warning has been cleared.

All the LEDs will be lit in yellow.

#### **Error**

The error codes are used to indicate that an error has occurred in the welding process. Errors will stop the welding and need to take the corrective action in the system.

All the LEDs will be lit in red.

## 5.2 DX - Remote module

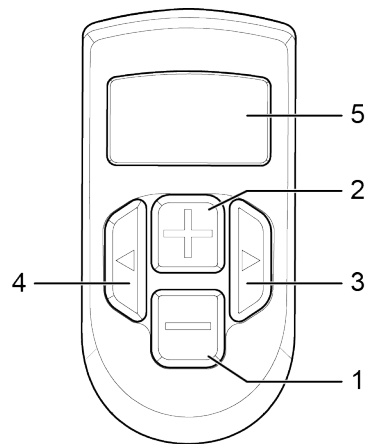

- |   |  |   |   |
|---|--|---|---|
| 1 | The Button to decrease the value       | 4 | The Button to change the views on right |
| 2 | The Button to increase the value       | 5 | Torch display                           |
| 3 | The Button to change the views on left |   |   |

### 5.2.1 Starting procedure

When the torch is connected to the system, it will display the ESAB logo and previous system settings by default.



### 5.2.2 Torch configuration

The functions need to be displayed on the torch can be selected from the Inner control panel of Robust Feed Edge under “Menu → System settings → Torch remote configuration → DX Torch module”. Turn ON “Activate Remote functionality”, to enable the required functions to be displayed on torch.

The torch remotes can be configured even if there are no torch remotes connected to the system. Changes in the configuration can have direct impact to the torch remote if it is connected and active.

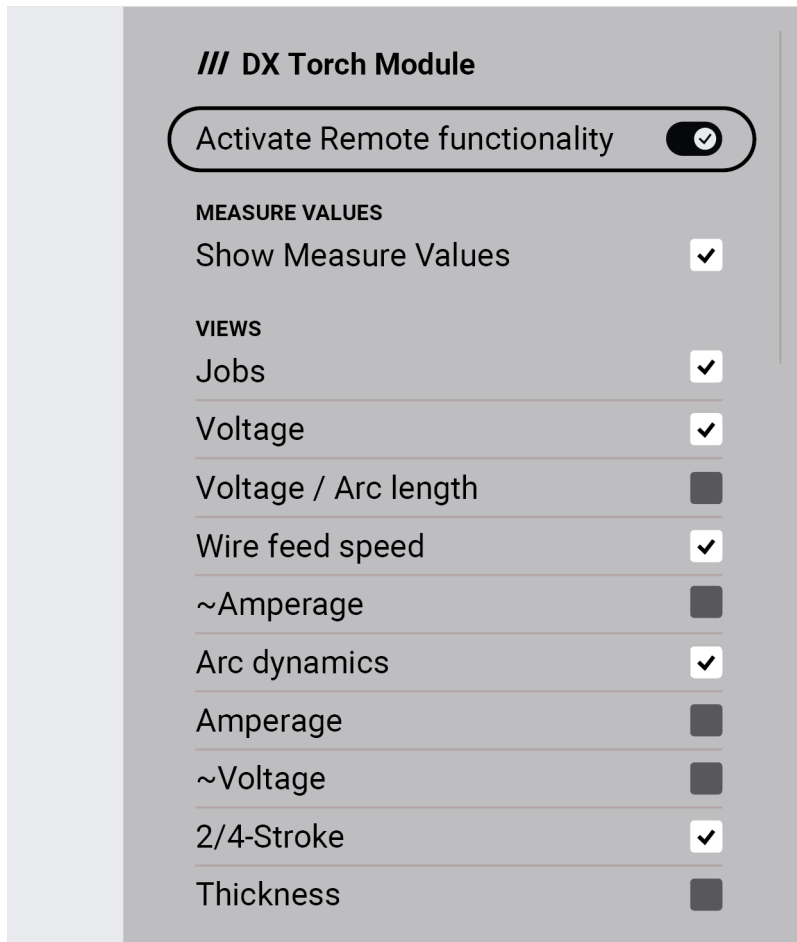

### 5.2.3 Functions



**NOTE!**

The display has a page indicator at the bottom. The indicator width changes depending on number of functions selected, and position depending on the index of the active display.

### Buttons (3 & 4)

By pressing the buttons (3 & 4), the functions can be moved to right and left respectively.

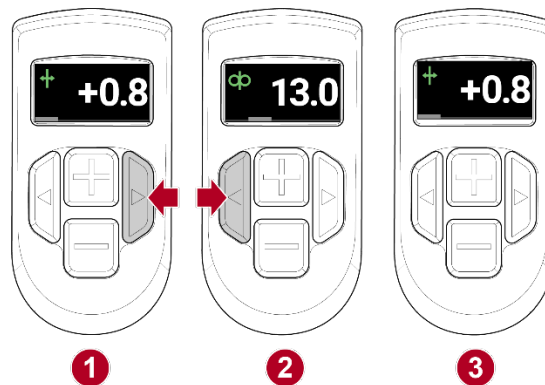

## Buttons (1 & 2)

By pressing the button (1 & 2), the values of the selected function can be decreased and increased respectively

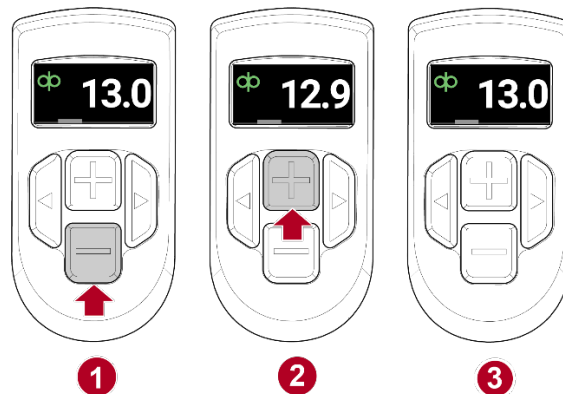

The decremental and incremental of the selected functional values are varied for a single button press as shown.

Function	Value
Jobs	1 Job
Wire feed speed	0.1 m/min 1 inch/min
2/4 stroke	B1 – 2 stroke B2 – 4 stroke
Current / Est Current	1 A
Voltage / Est Voltage	0.1 V
Dynamics	0.1
Thickness	1 thickness



### NOTE!

The unit of wire feed speed can only be set in the Inner control panel of Robust Feed Edge.



### NOTE!

For Wire feed speed, Voltage, Current, Dynamics and Thickness, the long press of buttons (1 & 2) will set to lower / upper limit values respectively.

### Sleep mode

After 10s of inactive, the display will be dimmed and for another 10s, the display will turn OFF.

Press any key to activate the torch.



### Lock screen

Long press the button (4), to lock / unlock the screen.

The lock symbol appears on the torch display and this restricts any changes to parameters



### Compensation mode

If the compensation mode is activated from the feeder, the torch cannot be used for welding applications. The compensation symbol appears on the torch display.

## 5.2.4 Warning / Error



### Unsupported process

The torch will be available in MIG/MAG welding applications only and not applicable for MMA, TIG and Gouging applications. The torch display appears as shown.



### Warning

The warning codes are used to indicate the warning message to show the critical limits. Warning does not stop ongoing welding, but prevent new welding until the warning has been cleared



### Error

The error codes are used to indicate that an error has occurred in the welding process. Errors will stop the welding and need to take the corrective action in the system.

## 5.3 Software upgrade procedure

The software upgrade procedure for the torches can be found in the Warrior Edge 500 service manual. Refer to section 7.1 and 7.2 on Document Number 0463844001.



### NOTE!

The software upgrade is applicable for DX remote modules only, not for CX remote modules.

## 6. MAINTENANCE

### 6.1 Overview



#### NOTE!

Regular maintenance is important for safe and reliable operation.

Cleaning and replacement of the welding torch's wear parts should take place at regular intervals to achieve trouble-free wire feed. Blow the wire guide clean regularly and clean the contact tip.



#### WARNING!

Before carrying out cleaning, servicing and repair work, the following shutdown procedure must be followed.

1. Switch off the power supply.
2. Close off the gas supply.

Make sure that the power supply and gas remain turned off all the time while servicing the equipment.

### 6.2 Cable assembly

Check the torch and cable assembly for damages prior to use. Damages must be repaired by qualified personnel before further use of the product.

### 6.3 Cleaning the wire feed

Disconnect the torch cable assembly from the equipment and lay it out straight.

Unscrew the nut and pull out the wire guide liner. Remove other parts from the swan neck.

Blow compressed air through the wire conduit from both ends in order to remove wire shavings.

Insert the liner into the wire conduit and screw the nut back on.



#### NOTE!

New liners must be cut to the correct length.

### 6.4 Steel liner / Plastic liner

If a wire feeding problem cannot be solved by exchanging the contact tip and cleaning the wire guide channel, the liner should be replaced.

Liner and welding wire should be inserted while the cable assembly is laid out straight.

## Installing a steel liner

1. Remove the sleeve nut from the central connector, remove the gas nozzle, contact tip and tip holder from the torch.
2. Insert the liner through the central connector and lock it with the sleeve nut.
3. Gently push back the front part of the liner into the torch as far as it will go, do not apply force. Mark the end of the torch neck on the liner.
4. Cut the liner to the correct length using a projectile "X" measured from the marking as shown in the figure.

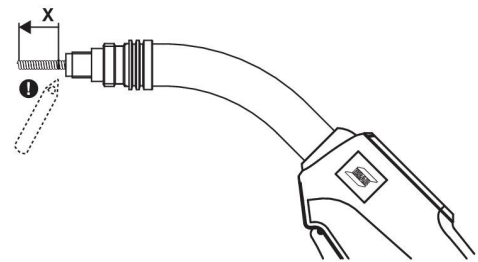
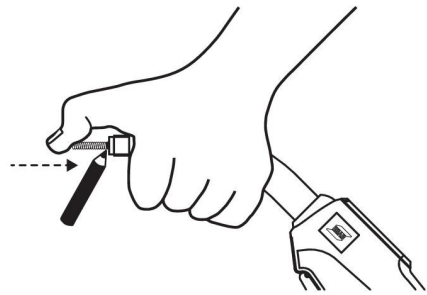

Remove the liner from the torch and carefully smoothen its front end. If needed, grind down burred edges. Make sure the inner hole is completely open.

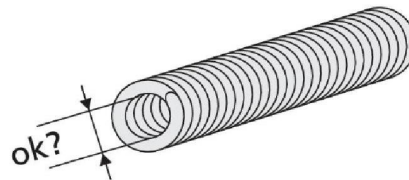

For insulated liners, remove the insulation at the front end so that the remaining insulation ends approximately at the front end of the torch handle.

Reinstall the liner and lock it with the sleeve nut. Install all equipment parts on the torch neck.

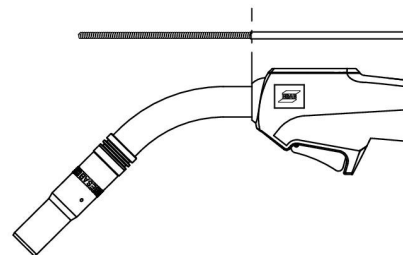

## Cutting length

Welding torch	Projectile "X"
Exeor MIG 4.0W <sup>2</sup>	12 mm
Exeor MIG 4.0G <sup>2</sup>	13 mm

## Installing a plastic liner

1. Remove the sleeve nut from the central connector, remove the gas nozzle, contact tip and tip holder from the torch.
2. Insert the liner through the central connector and lock it with the sleeve nut.
3. Gently push back the front part of the liner into the torch as far as it will go, do not apply force. Mark the end of the torch neck on the liner.
4. Cut the liner to the correct length using a projectile "X" measured from the marking as shown in the figure. Slightly chamfer the liner front end after the liner has been cut to the correct length.

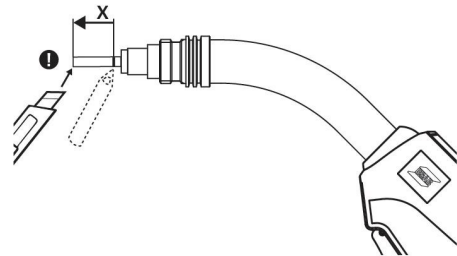
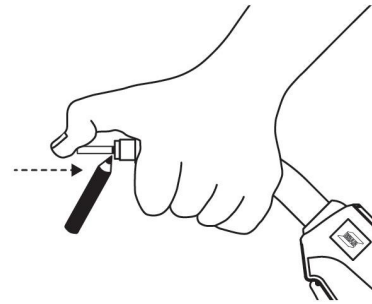

### NOTE!

If the liner has a bronze front end, first cut the plastic liner to a suitable length and let the bronze liner stick out approximately 40-50 mm from the torch neck. Attach the bronze liner to the front of the plastic liner and only then cut this liner assembly to the precise length.

If it is difficult to insert the liner into the torch, make a clean cut at the front end of the liner and chamfer the edges (e.g. with a pencil sharpener).



Install all equipment parts on the torch neck.

## Cutting length

Welding torch	Projectile "X"
Exeor MIG 4.0W <sup>2</sup>	9 mm
Exeor MIG 4.0G <sup>2</sup>	13 mm

## 6.5 Cleaning the swan neck

- Clean the inside of the gas nozzle regularly to remove welding spatter and spray with ESAB® anti-spatter agent.
- Check the consumables for visible damage and replace if necessary.

## 6.6 Checking the cooling system

Make sure that the cooling liquid is clean, change it if required. Impurities in the cooling liquid can obstruct the torch liquid channels. Always use suitable cooling fluid for torches with corrosion inhibitors.



## 7. TROUBLESHOOTING

If the measures described below are not successful, consult your dealer or the manufacturer.

Read the operating instructions for the welding components, e.g. power source and wire feed unit.

<b>Problem</b>	<b>Possible cause</b>	<b>Action</b>
Torch becomes too hot	<ul style="list-style-type: none"> <li>• Contact tip / tip holder not tight enough</li> <li>• Cooling system is not working well</li> <li>• Torch overstrained</li> <li>• Cable assembly defective</li> </ul>	<ul style="list-style-type: none"> <li>• Check and tighten hand-tight</li> <li>• Check liquid flow, filling level and cleanliness</li> <li>• Observe technical data, if needed, choose a different type</li> <li>• Check cables, tubes, and connections</li> </ul>
Wire feeding problems	<ul style="list-style-type: none"> <li>• Contact tip is worn</li> <li>• Liner is worn / dirty</li> <li>• Consumables used are not suitable for the wire diameter or material</li> <li>• Wire feeder not set-up properly</li> <li>• Cable assembly is bent or laid out in small radii</li> <li>• Wire is contaminated</li> </ul>	<ul style="list-style-type: none"> <li>• Exchange contact tip</li> <li>• Check the liner, blow through in both directions. Exchange if needed.</li> <li>• Check with spare part list</li> <li>• Check the wire feeding rolls, the contact pressure and the spool brake</li> <li>• Check the cable assembly and lay it out straight</li> <li>• Use a cleaning felt</li> </ul>
Porous welds	<ul style="list-style-type: none"> <li>• Gas swirl caused by spatter adherence</li> <li>• Too small or extremely high gas flow in the torch</li> <li>• Gas supply defective</li> <li>• Air draft at the workplace</li> <li>• Moisture or contamination on the wire or on the work piece</li> </ul>	<ul style="list-style-type: none"> <li>• Clean the torch head, use gas diffuser / spatter protection</li> <li>• Check flow rate with measurement tool</li> <li>• Check flow rate and possible leakage</li> <li>• Install shielding</li> <li>• Check the wire and the work piece, use less or different anti-spatter liquid</li> </ul>
Variable arc	<ul style="list-style-type: none"> <li>• Contact tip is worn</li> <li>• Wrong welding parameters</li> </ul>	<ul style="list-style-type: none"> <li>• Exchange contact tip</li> <li>• Correct the welding parameters</li> </ul>
Welding process does not start	<ul style="list-style-type: none"> <li>• Control cable is broken, or the trigger is defective</li> </ul>	<ul style="list-style-type: none"> <li>• Check and repair the trigger connections, clean the trigger switch or exchange it</li> </ul>

## 8. DISASSEMBLY AND DISPOSAL



### NOTE!

#### Dispose of electronic equipment at the recycling facility!

In observance of European Directive 2012/19/EC on Waste Electrical and Electronic Equipment and its implementation in accordance with national law, electrical and/or electronic equipment that has reached the end of its life must be disposed of at a recycling facility.

As the person responsible for the equipment, it is your responsibility to obtain information on approved collection stations.

For further information contact the nearest ESAB dealer.



The welding torch system is mainly made from steel, plastics and non-ferrous metal, and must be disposed of in accordance with local environmental regulations.

## 9. IN THE EVENT OF EMERGENCY



### DANGER!

In the event of an emergency, the power source must be switched off immediately. For further action in such circumstances, refer to the instruction manual of the power source for more information.

## 10. ORDERING PARTS



### CAUTION!

Repair and electrical work should be performed by an authorized ESAB service technician. Use only ESAB original spare and wear parts.

The Exeor torches are designed and tested in accordance with international and European standards IEC/EN 60974-7,2019. On completion of service or repair work, it is the responsibility of the person(s) performing the work to ensure that the product still complies with the requirements of the above standard.

Spare parts and wear parts can be ordered through your nearest ESAB dealer, see [esab.com](http://esab.com). When ordering, please state product type, serial number, designation, and spare part number in accordance with the spare parts list. This facilitates dispatch and ensures correct delivery.

## 11. ORDERING NUMBERS

Ordering no.	Denomination	Type	Notes
Water-cooled Exeor Torch			
0700 025 730	Exeor MIG 4.0W <sup>2</sup> CX	Welding torch 3 m	with CX Remote Control
0700 025 731	Exeor MIG 4.0W <sup>2</sup> CX	Welding torch 4 m	with CX Remote Control
0700 025 732	Exeor MIG 4.0W <sup>2</sup> CX	Welding torch 5 m	with CX Remote Control
0700 025 733	Exeor MIG 4.0W <sup>2</sup> DX	Welding torch 3 m	with DX Remote Control
0700 025 734	Exeor MIG 4.0W <sup>2</sup> DX	Welding torch 4 m	with DX Remote Control
0700 025 735	Exeor MIG 4.0W <sup>2</sup> DX	Welding torch 5 m	with DX Remote Control
0700 026 050	Exeor MIG 4.0W <sup>2</sup>	Welding torch 3 m	with No Remote Control
0700 026 051	Exeor MIG 4.0W <sup>2</sup>	Welding torch 4 m	with No Remote Control
0700 026 052	Exeor MIG 4.0W <sup>2</sup>	Welding torch 5 m	with No Remote Control
Gas-cooled Exeor Torch			
0700 025 755	Exeor MIG 4.0G <sup>2</sup> CX	Welding torch 3 m	with CX Remote Control
0700 025 756	Exeor MIG 4.0G <sup>2</sup> CX	Welding torch 4 m	with CX Remote Control
0700 025 757	Exeor MIG 4.0G <sup>2</sup> CX	Welding torch 5 m	with CX Remote Control
0700 025 758	Exeor MIG 4.0G <sup>2</sup> DX	Welding torch 3 m	with DX Remote Control
0700 025 759	Exeor MIG 4.0G <sup>2</sup> DX	Welding torch 4 m	with DX Remote Control
0700 025 760	Exeor MIG 4.0G <sup>2</sup> DX	Welding torch 5 m	with DX Remote Control
0700 026 056	Exeor MIG 4.0G <sup>2</sup>	Welding torch 3 m	with No Remote Control
0700 026 057	Exeor MIG 4.0G <sup>2</sup>	Welding torch 4 m	with No Remote Control
0700 026 058	Exeor MIG 4.0G <sup>2</sup>	Welding torch 5 m	with No Remote Control

## 12. REPLACING THE PCBA BOARD



### CAUTION!

The replacing procedure should be carried out by authorized service technician.

For replacing the PCBA board, refer “Replacement instructions” section in the Service manual (0700 026 112).

## 13. SPARE PARTS

### 13.1 Exeor MIG 4.0W<sup>2</sup> CX, DX

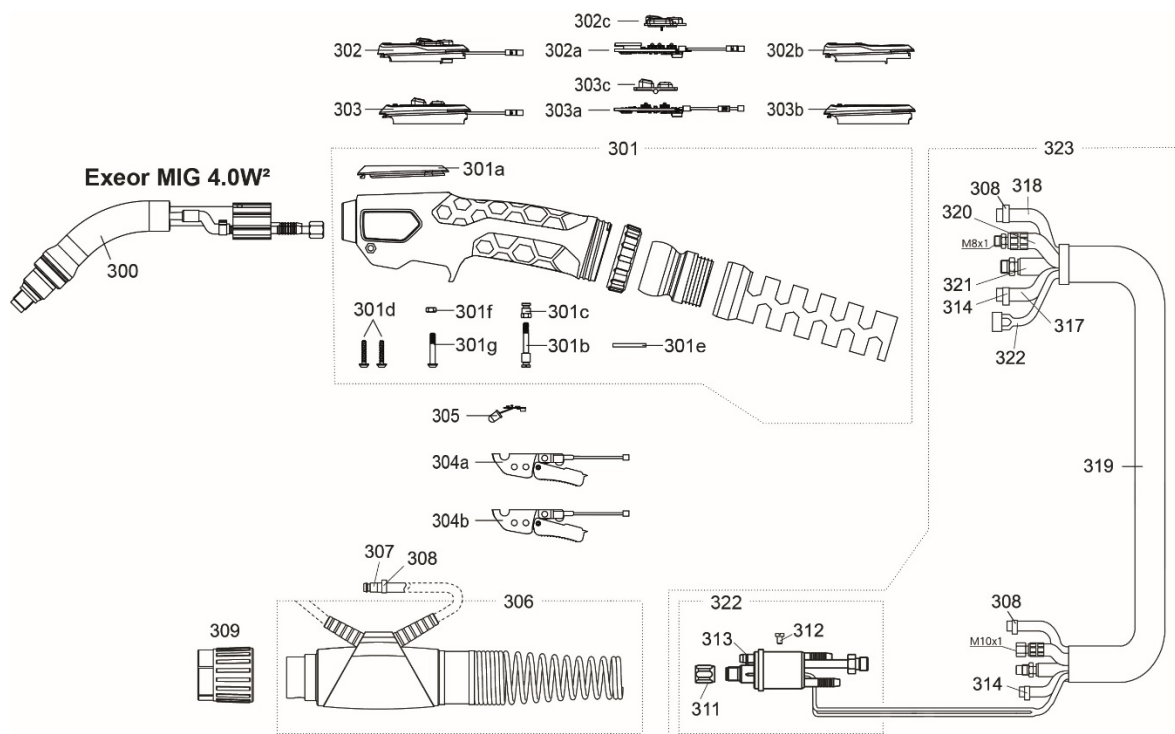

Item	Qty.	Ordering no.	Denomination	Notes
300	1	0700 025 011	Torch neck 4.0W <sup>2</sup>	
301	1	0700 026 101	Handle w/o torch neck; remote	
301a	1	B01P600222	Blind Cover	
301b	1	B01P600230	Handle Holder Screw	
301c	1	B01P600231	Handle Holder Nut	
301d	2		Screw	EJOT Delta PT WN 5451, 3.0×16
301e	1	B01P600229	Snap-in Plate	
301f	2		Nut M3.5	DIN EN 24032
301g	2	B01P102090	Screw	M3.5×20 T10
302	1	0700 025 747	Spare parts kit DX, water	includes 302a, 302b, 302c, 305
302a	1		DX PCBA	with Harness
302b	1	B01P600123	Housing Kit	Exeor MIG DX
302c	1	B01P600275	Push button R/L	Exeor MIG DX
302c	1	B01P600276	Push button P/M	Exeor MIG DX

Item	Qty.	Ordering no.	Denomination	Notes
303	1	0700 025 748	Spare parts kit CX, water	includes 303a, 303b, 303c, 305
303a	1		CX PCBA	with Harness
303b	1	B01P600114	Housing Kit	Exeor MIG CX
303c	1	B01P600116	Push button cover	Exeor MIG CX
304a	1	0700 025 793	Trigger Unit with harness; for remote System	with LED
304b	1	0700 025 794	Trigger Unit with harness; non-remote System	without LED
305	1	0700 025 082	PCBA LED f. Exeor Handle cpl.	
306	1	0700 025 971	Cable support cpl.	
307	2	0700 025 973	Quick connector	
308	4		Hose clamp with ring	Ø9.0 OETIKER 15400021
309	1	0700 025 951	Adaptor nut	
311	1	0700 200 098	Liner locking nut	
312	1		Screw	M4×6; ISO 7048 TYPE H, 8.8 A2K
313	1		O-ring	4.0×1.0 mm (ID×S) NBR 70 Shore A
314	2		Hose clamp with ring	Ø8.7 OETIKER 15400020
317	1	0700 025 993	PVC-Gas hose	6 m, black, 4.5×1.5 mm
318	1	0700 025 994	PVC hose, braided	6 m, black, 5.0×1.5 mm
319	1	0700 026 092	Assembly outer hose 3 m	
319	1	0700 026 093	Assembly outer hose 4 m	
319	1	0700 026 094	Assembly outer hose 5 m	
320	1	0700 025 983	Water-power cable 3 m	
320	1	0700 025 984	Water-power cable 4 m	
320	1	0700 025 985	Water-power cable 5 m	
321	1	0700 026 000	Wire conduit 3 m	
321	1	0700 026 001	Wire conduit 4 m	
321	1	0700 026 002	Wire conduit 5 m	
322	1	0700 026 082	Control cable kit 3 m, with Euro connector for Exeor torches	
322	1	0700 026 083	Control cable kit 4 m, with Euro connector for Exeor torches	
322	1	0700 026 084	Control cable kit 5 m, with Euro connector for Exeor torches	
323	1	0700 026 003	Cable assembly 3 m	Including 322
323	1	0700 026 004	Cable assembly 4 m	Including 322
323	1	0700 026 005	Cable assembly 5 m	Including 322

## 13.2 Exeor MIG 4.0W<sup>2</sup>

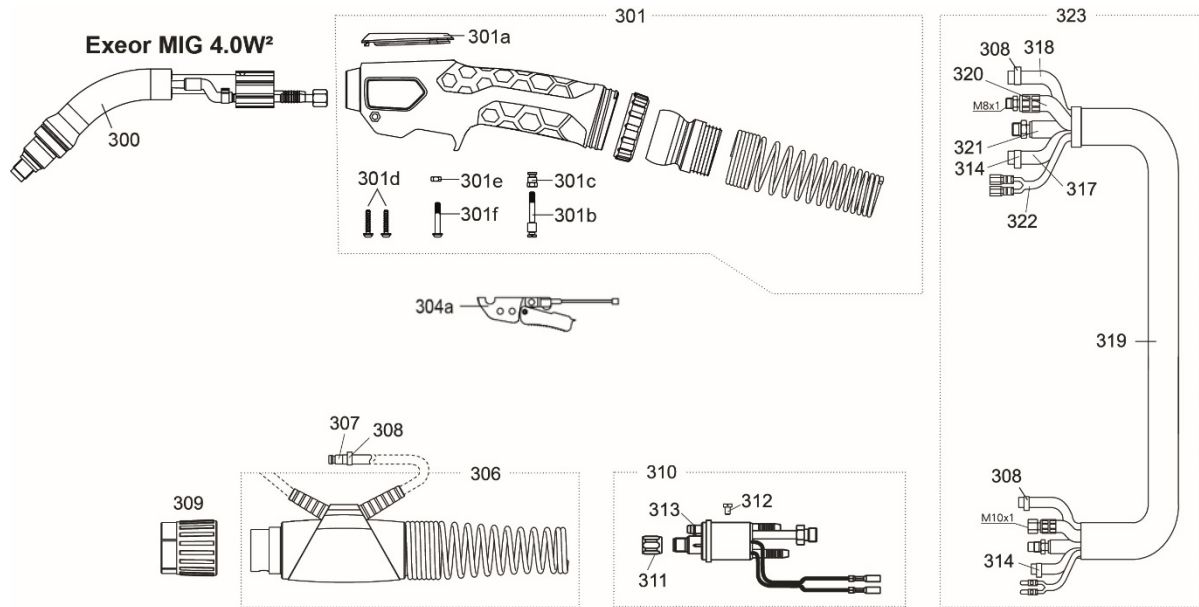

Item	Qty.	Ordering no.	Denomination	Notes
300	1	0700 025 011	Torch neck 4.0W <sup>2</sup>	
301	1	0700 026 102	Handle w/o torch neck	
301a	1	B01P600222	Blind Cover	
301b	1	B01P600230	Handle Holder Screw	
301c	1	B01P600231	Handle Holder Nut	
301d	2		Screw	EJOT Delta PT WN 5451, 3.0×16
301e	1		Nut	M3.5 DIN EN 24032
301f	1	B01P102090	Screw	M3.5×20 T10
304a	1	B01P600285	Trigger Unit	2-poles without LED
306	1	0700 025 971	Cable support cpl.	
307	2	0700 025 973	Quick connector	
308	4		Hose clamp with ring	Ø9.0 OETIKER 15400021
309	1	0700 025 951	Adaptor nut	
310	1	0700 025 970	Central connector W	
311	1	0700 200 098	Liner locking nut	
312	1		Screw	M4×6; ISO 7048 TYPE H, 8.8 A2K
313	1		O-ring	4.0×1.0 mm (ID×S) NBR 70 Shore A
314	2		Hose clamp with ring	Ø8.7 OETIKER 15400020

<b>Item</b>	<b>Qty.</b>	<b>Ordering no.</b>	<b>Denomination</b>	<b>Notes</b>
317	1	0700 025 993	PVC-Gas hose	6 m, black, 4.5×1.5 mm
318	1	0700 025 994	PVC hose, braided	6 m, black, 5.0×1.5 mm
319	1	0700 026 092	Assembly outer hose 3 m	
319	1	0700 026 093	Assembly outer hose 4 m	
319	1	0700 026 094	Assembly outer hose 5 m	
320	1	0700 025 983	Water-power cable 3 m	
320	1	0700 025 984	Water-power cable 4 m	
320	1	0700 025 985	Water-power cable 5 m	
321	1	0700 026 000	Wire conduit 3 m	
321	1	0700 026 001	Wire conduit 4 m	
321	1	0700 026 002	Wire conduit 5 m	
322	1	0700 025 989	Control cable cpl. 3 m	
322	1	0700 025 990	Control cable cpl. 4 m	
322	1	0700 025 991	Control cable cpl. 5 m	
323	1	0700 026 098	Cable assembly 3 m	
323	1	0700 026 099	Cable assembly 4 m	
323	1	0700 026 100	Cable assembly 5 m	

### 13.3 Exeor MIG 4.0G<sup>2</sup> CX, DX

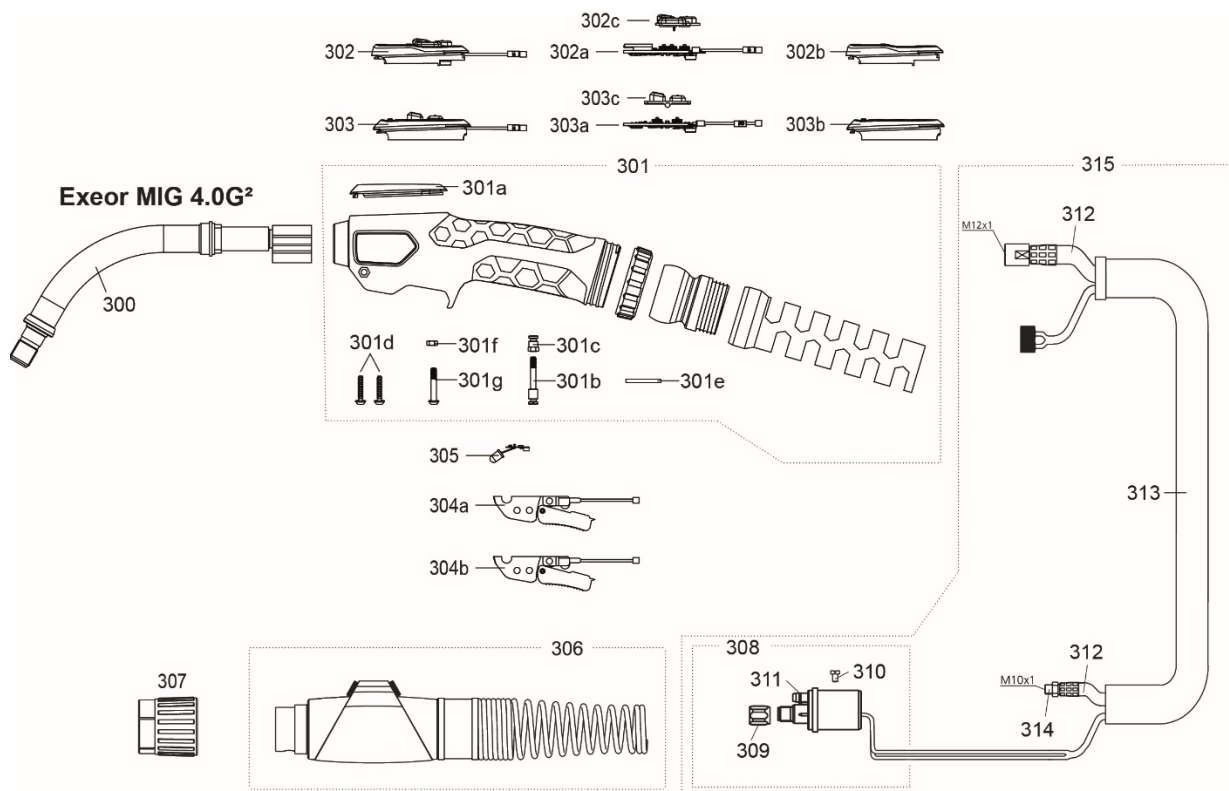

Item	Qty.	Ordering no.	Denomination	Notes
300	1	0700 026 091	Torch neck S Exeor MIG 4.0G <sup>2</sup>	
301	1	0700 026 101	Handle w/o torch neck; remote	
301a	1	B01P600222	Blind Cover	
301b	1	B01P600230	Handle Holder Screw	
301c	1	B01P600231	Handle Holder Nut	
301d	2		Screw	EJOT Delta PT WN 5451, 3.0×16
301e	1	B01P600229	Snap-in Plate	
301f	1		Nut	M3.5 DIN EN 24032
301g	1	B01P102090	Screw	M3.5×20 T10
302	1	0700 026 142	Spare parts kit DX, gas	includes 302a, 302b, 302c, 305
302a	1		DX PCBA	with Harness
302b	1	B01P600123	Housing Kit	Exeor MIG DX
302c	1	B01P600275	Push button R/L	Exeor MIG DX
302c	1	B01P600276	Push button P/M	Exeor MIG DX
303	1	0700 026 143	Spare parts kit CX, gas	includes 303a, 303b, 303c, 305
303a	1		CX PCBA	with Harness
303b	1	B01P600114	Housing Kit	Exeor MIG CX
303c	1	B01P600116	Push button cover	Exeor MIG CX
304a	1	0700 025 793	Trigger Unit with harness; for remote System	with LED



<b>Item</b>	<b>Qty.</b>	<b>Ordering no.</b>	<b>Denomination</b>	<b>Notes</b>
304b	1	0700 025 794	Trigger Unit with harness; non-remote System	without LED
305	1	0700 025 082	PCBA LED f. Handle cpl.	
306	1	0700 025 971	Cable support cpl.	
307	1	0700 025 951	Adaptor nut	
308	1	0700 026 109	Control cable kit 3 m, gas with Euro connector for Exeor torches	
308	1	0700 026 110	Control cable kit 4 m, gas with Euro connector for Exeor torches	
308	1	0700 026 111	Control cable kit 5 m, gas with Euro connector for Exeor torches	
309	1	0700 200 098	Liner locking nut	
310	1		Screw	M4×6 ISO 7048 TYPE H, 8.8 A2K
311	1		O-ring	4.0×1.0 mm (ID×S) NBR 70 Shore A
312	1	0700 026 034	Power cable 3 m	
312	1	0700 026 035	Power cable 4 m	
312	1	0700 026 036	Power cable 5 m	
313	1	0700 026 092	Assembly outer hose 3 m	
313	1	0700 026 093	Assembly outer hose 4 m	
313	1	0700 026 094	Assembly outer hose 5 m	
314	1	101P002005	Hex nut	M10×1
315	1	0700 026 095	Cable assembly 3 m	Includes 308
315	1	0700 026 096	Cable assembly 4 m	Includes 308
315	1	0700 026 097	Cable assembly 5 m	Includes 308

## 13.4 Exeor MIG 4.0G<sup>2</sup>

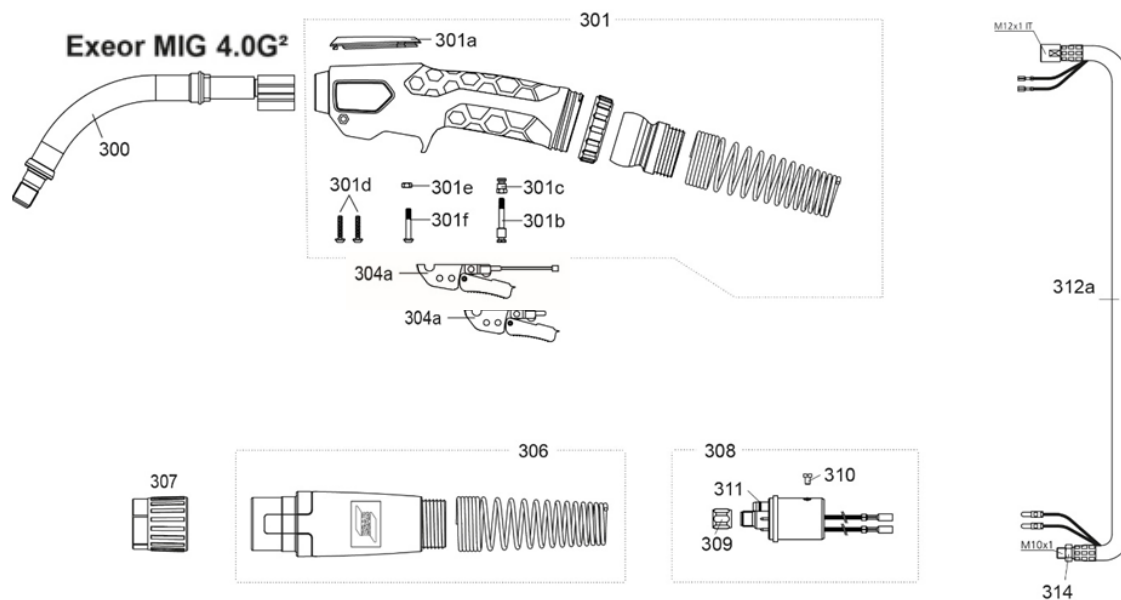



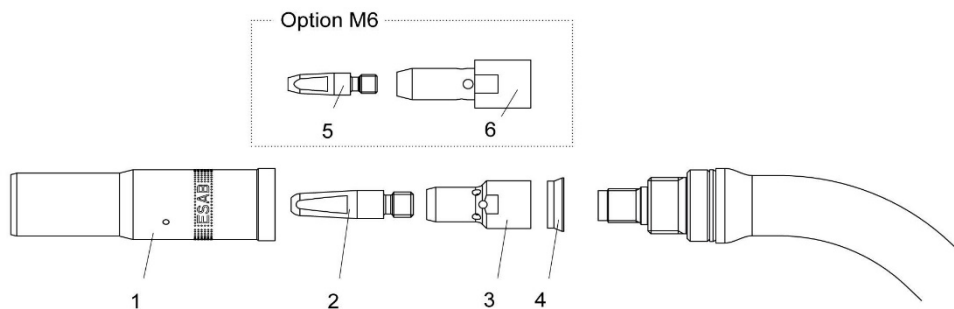

Item	Qty.	Ordering no.	Denomination	Notes
300	1	0700 026 091	Torch neck S Exeor MIG 4.0G <sup>2</sup>	
301	1	0700 026 102	Handle w/o torch neck	
301a	1	B01P600222	Blind Cover	
301b	1	B01P600230	Handle Holder Screw	
301c	1	B01P600231	Handle Holder Nut	
301d	2		Screw	EJOT Delta PT WN 5451, 3.0×16
301e	1		Nut	M3.5 DIN EN 24032
301f	1	B01P102090	Screw	M3.5×20 T10
304a	1	B01P600285	Trigger Unit	2-poles without LED
306	1	0700 025 950	Cable support cpl.	
307	1	0700 025 951	Adaptor nut	
308	1	0700 200 101	Central connector G	
309	1	0700 200 098	Liner locking nut	
310	1		Screw	M4×6 ISO 7048 TYPE H, 8.8 A2K
311	1		O-ring	4.0×1.0 mm (ID×S) NBR 70 Shore A
312a	1	361P3LBB30	Power Cable 3 m, 70 <sup>2</sup> mm	
312a	1	361P3LBB40	Power Cable 4 m, 70 <sup>2</sup> mm	
312a	1	361P3LBB50	Power Cable 5 m, 70 <sup>2</sup> mm	
314	1	101P002005	Hex nut	M10×1

## 14. WEAR PARTS Exeor MIG 4.0W<sup>2</sup>

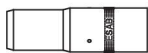
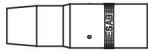
1. Gas nozzle
2. Contact tip M8 × 37
3. Tip adaptor M8
4. Insulation bushing
5. Contact tip M6 × 27
6. Tip adaptor M6

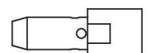

Ordering no.	Denomination	Notes	Ø	Length	
0458 464 882	Gas nozzle	Standard	16 mm	80 mm	
0458 465 882	Gas nozzle	Conical	14 mm	80 mm	
0458 470 882	Gas nozzle	Straight	19 mm	80 mm	
0366 394 001	Tip adaptor M6	-	-	40.6 mm	
0460 819 001	Tip adaptor M8 Cu	-	-	31.6 mm	
0700 025 851	Tip adaptor M8 brass	-	-	31.6 mm	
0458 874 001	Insulation washer	-	-	-	

### 14.1 Contact Tips M8

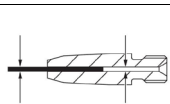
Exeor MIG 4.0W <sup>2</sup>	Gas / wire Ø		
	CO <sub>2</sub>	Mix/Ar	
0468 502 003	0.8	-	W0.8 / 1.0
0468 502 004	0.9	0.8	W1.0 / 1.1
0468 502 005	1.0	0.9	W1.0 / 1.2
0468 502 006	1.2	-	W1.2 / 1.4
0468 502 007	1.2	1.0	W1.2 / 1.5
0468 502 008	1.4	1.2	W1.4 / 1.7
0468 502 009	1.6	-	W1.6 / 1.9
0468 502 010	-	1.6	W1.6 / 2.1

## 14.2 Contact Tips M6

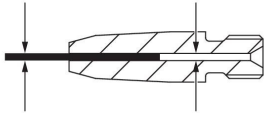
Exeor MIG 4.0W <sup>2</sup>	Gas / wire Ø		
	M6	M6	
	CO <sub>2</sub>	Mix/Ar	M6
0468 500 001	0.6	-	W0.6 / 0.8
0468 500 002	-	0.6	W0.8 / 0.9
0468 500 003	0.8	-	W0.8 / 1.0
0468 500 004	0.9	0.8	W0.9 / 1.1
0468 500 005	1.0	0.9	W1.0 / 1.2
0468 500 006	1.2	-	W1.2 / 1.4
0468 500 007	1.2	1.0	W1.2 / 1.5
0468 500 008	1.4	1.2	W1.4 / 1.7
0468 500 009	1.6	-	W1.6 / 1.9
0468 500 010	-	1.6	W1.6 / 2.1

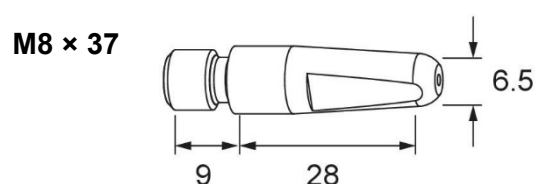
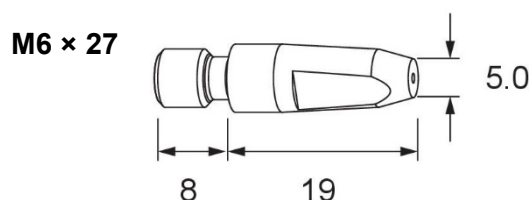

## 14.3 Steel liner

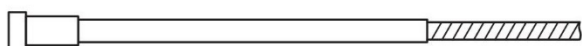

Ordering no.	Ø	Length	Notes	Exeor MIG 4.0W <sup>2</sup>
0700 025 822	0.9 – 1.2	3 m	Red HD	X
0700 025 823	0.9 – 1.2	4 m	Red HD	X
0700 025 824	0.9 – 1.2	5 m	Red HD	X
0700 025 825	1.4 – 1.6	3 m	Grey HD	X
0700 025 826	1.4 – 1.6	4 m	Grey HD	X
0700 025 827	1.4 – 1.6	5 m	Grey HD	X

## 14.4 PTFE liner

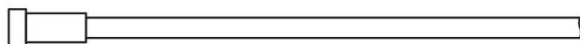

Ordering no.	Ø	Length	Notes	Exeor MIG 4.0W <sup>2</sup>
0700 200 089	0.8 – 1.0	3 m	Blue	X
0700 200 090	0.8 – 1.0	4 m	Blue	X
0700 025 811	0.8 – 1.0	5 m	Blue	X
0700 200 091	1.0 – 1.2	3 m	Red	X
0700 200 092	1.0 – 1.2	4 m	Red	X
0700 025 812	1.0 – 1.2	5 m	Red	X
0700 025 813	1.2 – 1.6	3 m	Yellow	X
0700 025 814	1.2 – 1.6	4 m	Yellow	X
0700 025 815	1.2 – 1.6	5 m	Yellow	X

## 14.5 PTFE liner with bronze front end



Ordering no.	Ø	Length	Notes	Exeor MIG 4.0W <sup>2</sup>
0700 026 073	0.8	3 m	blue	X
0700 026 074	0.8	4 m	blue	X
0700 026 075	0.8	5 m	blue	X
0700 026 076	1.0	3 m	red	X
0700 026 077	1.0	4 m	red	X
0700 026 078	1.0	5 m	red	X
0700 026 079	1.2 – 1.6	3 m	yellow	X
0700 026 080	1.2 – 1.6	4 m	yellow	X
0700 026 081	1.2 – 1.6	5 m	yellow	X

## 14.6 PA liner with bronze front end

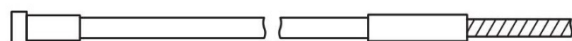



Ordering no.	Ø	Length	Notes	Exeor MIG 4.0W <sup>2</sup>
0700 025 816	0.8 – 1.0	3 m	Anthracite	X
0700 025 817	0.8 – 1.0	4 m	Anthracite	X
0700 025 818	0.8 – 1.0	5 m	Anthracite	X
0700 025 819	1.2 – 1.6	3 m	Anthracite	X
0700 025 820	1.2 – 1.6	4 m	Anthracite	X
0700 025 821	1.2 – 1.6	5 m	Anthracite	X

## 15. WEAR PARTS Exeor MIG 4.0G<sup>2</sup>

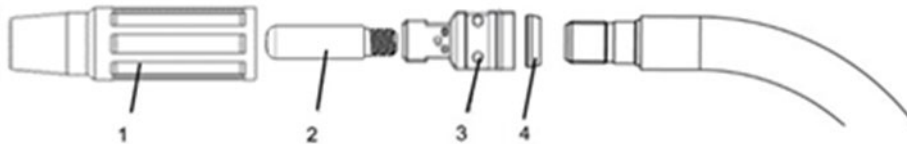
1. Gas nozzle
2. Contact tip 16S-Series
3. Diffuser HD54-16
4. Insulation bushing

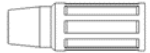
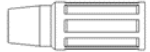
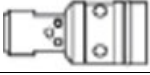

Ordering no.	Denomination	Notes	Ø	Length	
12401200	Gas nozzle, HD24L-50	Option	12,7 mm (1/2")	80 mm	
<b>12401201</b>	<b>Gas nozzle HD24L-62</b>	<b>Standard</b>	<b>15,9 mm (5/8")</b>	<b>80 mm</b>	
12401202	Gas nozzle, HD24L-75	Option	19,5 mm (.767")	80 mm	
<b>15401136</b>	<b>Diffuser, HD54-16</b>	<b>Standard</b>	-	<b>49.6 mm</b>	
<b>0700025854</b>	<b>Insulation bushing</b>	-	<b>17,5 mm (.688")</b>	<b>6,0 mm (.236")</b>	

### 15.1 Contact Tips; Standard 16S-Series

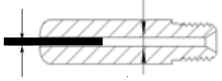
Exeor MIG 4.0G Stock No.		
Mix/Ar <b>M8x1.25</b>	Wire Size (mm / in)	Tip I.D. (mm / in)
11601102	0.90 mm (.035")	1.12 mm (.044")
11601103	1.00 mm (.040")	1.22 mm (.048")
11601104	1.20 mm (.045")	1.37 mm (.054")
11601105	1.30 mm (.052")	1.65 mm (.064")
11601106	1.60 mm (1/16")	1.85 mm (.073")
11601113	AL 1.20 mm (3/64")	1.50 mm (.059")
11601114	AL 1.60 mm (1/16")	2.08 mm (.082")

**M8x1.25**

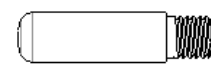

**38.1 mm (1.50")**

## 15.2 Steel liner

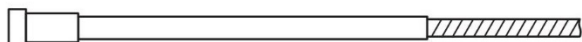

Ordering no.	Ø	Length	Notes	Exeor MIG 4.0G <sup>2</sup>
0700 025 822	0.9 – 1.2	3 m	Red HD	X
0700 025 823	0.9 – 1.2	4 m	Red HD	X
0700 025 824	0.9 – 1.2	5 m	Red HD	X
0700 025 825	1.4 – 1.6	3 m	Grey HD	X
0700 025 826	1.4 – 1.6	4 m	Grey HD	X
0700 025 827	1.4 – 1.6	5 m	Grey HD	X

## 15.3 PTFE liner

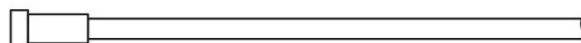

Ordering no.	Ø	Length	Notes	Exeor MIG 4.0G <sup>2</sup>
0700 200 089	0.8 – 1.0	3 m	Blue	X
0700 200 090	0.8 – 1.0	4 m	Blue	X
0700 025 811	0.8 – 1.0	5 m	Blue	X
0700 200 091	1.0 – 1.2	3 m	Red	X
0700 200 092	1.0 – 1.2	4 m	Red	X
0700 025 812	1.0 – 1.2	5 m	Red	X
0700 025 813	1.2 – 1.6	3 m	Yellow	X
0700 025 814	1.2 – 1.6	4 m	Yellow	X
0700 025 815	1.2 – 1.6	5 m	Yellow	X

## 15.4 PTFE liner with bronze front end

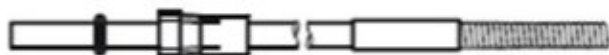

Ordering no.	Ø	Length	Notes	Exeor MIG 4.0W <sup>2</sup>
0700 026 073	0.8	3 m	blue	X
0700 026 074	0.8	4 m	blue	X
0700 026 075	0.8	5 m	blue	X
0700 026 076	1.0	3 m	red	X
0700 026 077	1.0	4 m	red	X
0700 026 078	1.0	5 m	red	X
0700 026 079	1.2 – 1.6	3 m	yellow	X
0700 026 080	1.2 – 1.6	4 m	yellow	X
0700 026 081	1.2 – 1.6	5 m	yellow	X

## 15.5 PA liner with bronze front end



Ordering no.	Ø	Length	Notes	Exeor MIG 4.0G <sup>2</sup>
0700 025 816	0.8 – 1.0	3 m	Anthracite	X
0700 025 817	0.8 – 1.0	4 m	Anthracite	X
0700 025 818	0.8 – 1.0	5 m	Anthracite	X
0700 025 819	1.2 – 1.6	3 m	Anthracite	X
0700 025 820	1.2 – 1.6	4 m	Anthracite	X
0700 025 821	1.2 – 1.6	5 m	Anthracite	X





# A WORLD OF PRODUCTS AND SOLUTIONS.



For contact information visit [esab.com](http://esab.com)

ESAB AB, Lindholmsallén 9, Box 8004, 402 77 Gothenburg, Sweden, Phone +46 (0) 31 50 90 00

<http://manuals.esab.com>

